

P/N : 388062805
PRINTED IN KOREA

Distributed by

USER MANUAL

Full HD Mega-pixel Rugged PTZ Camera



Before attempting to connect or operate this product, please read this instruction carefully and save this manual for future use.

TABLE OF CONTENTS

1. INFORMATION FOR USER	3p.
1.1 WARNING	3p.
1.2 EXPLANATION OF GRAPHICAL SYMBOLS	3p.
1.3 FCC COMPLIANCE STATEMENT	3p.
2. PRECAUTIONS	4p.
3. FEATURES	5p.
4. SETTING & INSTALLATION	6p.
4.1 Unpacking	6p.
4.2 DIP Switch Setting	7p.
4.3 Cable connection.....	10p.
4.4 Installation	11p.
4.5 Basic Configuration.....	12p.
5. MAIN SETUP MENU	13p.
5.1 Initialize	13p.
5.2 Motion Setting	13p.
5.3 Dome Setting	36p.
5.4 Clear Setting.....	44p.
5.5 Special Setting.....	44p.
5.6 PTZ Reset	44p.
5.7 Other Quick Opercating Guide	45P.
6. SPECIFICATIONS	46p.
6.1 Mechanical specifications	46p.
6.2 LED Specification	47p.
7. DIMENSIONS	48p.

1. INFORMATION FOR USER

1.1 WARNING

TO REDUCE THE RISK OF FIRE OR ELECTRIC SHOCK, DO NOT EXPOSE THIS PRODUCT TO RAIN OR MOISTURE. DO NOT INSERT ANY METALLIC OBJECTS THROUGH THE VENTILATION GRILLS OR OTHER OPENINGS ON THE EQUIPMENT.



CAUTION
RISK OF ELECTRIC SHOCK
DO NOT OPEN



CAUTION : TO REDUCE THE RISK OF ELECTRIC SHOCK, DO NOT REMOVE COVER (OR BACK). NO USER SERVICEABLE PARTS INSIDE. REFER SERVICING TO QUALIFIED SERVICE PERSONNEL.

1.2 EXPLANATION OF GRAPHICAL SYMBOLS



The lightning flash with an arrowhead symbol, within an equilateral triangle is intended to alert the user to the presence of uninsulated "dangerous voltage" within the product's enclosure that may be of sufficient magnitude to constitute a risk of electric shock to persons.



The exclamation point within an equilateral triangle is intended to alert the user to the presence of important operating and maintenance (servicing) instructions in the literature accompanying the appliance.

1.3 FCC COMPLIANCE STATEMENT

FCC INFORMATION - This equipment has been tested and found to comply with limits for a Class A digital device, pursuant to part 15 of the FCC Rules. These limits are designed to provide reasonable protection against harmful interference when the equipment is operated in a commercial environment. This equipment generates, uses, and can radiate radio frequency energy and, if not installed and used in accordance with the instruction manual, may cause harmful interference to radio communications. Operation of this equipment in a residential area is likely to cause harmful interference in which case the user will be required to correct the interference at his own expense.

1.4 CE COMPLIANCE STATEMENT

WARNING - This is a CLASS A product. In a domestic environment this product may cause radio interference in which case the user may be required to take adequate measures.

CAUTION - Changes or modifications not expressly approved by the manufacturer could void the user's authority to operate the equipment.

***This installation should be made by a qualified service person and should conform to all local codes.*

2. PRECAUTIONS

- **Do not install the camera in extreme temperature conditions.**

Do not use the camera under conditions where temperatures are within -20°C to 60°C (in continuous operation). Under high temperatures, ensure proper ventilation.

- **Do not install or use the camera in an environment where the humidity is high.**

It can cause the image quality to be poor.

- **Do not install the camera under unstable lighting conditions.**

Severe lighting change or flicker can cause the camera to work improperly.

- **Never use the camera close to a gas or oil leak.**

It can cause malfunctions to occur.

- **Do not disassemble the camera.**

There are no user-serviceable parts inside it.

- **Do not drop the camera or subject them to physical shocks.**

It can cause malfunctions to occur.

- **Do not allow direct sunlight into the camera.**

It can damage CCD.

- **Do not expose the camera to rain or spill beverages on it.**

If it gets wet, wipe it dry immediately. Liquids can contain minerals that corrode the electronic components.

- **To prevent electric shock and risk of fire hazards.**

- **Do not use power sources other than that specified.**

- **Note**

If the camera is exposed to spotlight or object reflecting the strong light, smear or blooming may occur.

Please check the power whether it satisfies the normal specification before connecting the camera.

3. FEATURES

Outdoor Heavy-duty PTZ Camera

Heavy-duty aluminum die-cast body allows WTK Series is ideal for traffic control, harbor and airport surveillance, oil fields & refineries, the military & police, sport stadiums, town & city centers, bus & rail stations and other high security outdoor installations.

Unobstructed 360° rotation and 180° flip

Heavy-duty long life slip ring allows for 360° endless panning and unobstructed 180° flip.

Light Function

It's built-in 30 pcs Super IR LED (Infra-red or white).

Built-in Fan & Heater

Built-in Wiper System

T rue Day & Night (ICR Filter Change)

The IR cut filter is when the camera is operating as a color camera for precise color reproduction. With ICR, the filter is removed which allows for much greater light sensitivity in monochrome mode.

Break and clutch protected pan and tilt

OSD (On Screen Display)

The camera IDs, camera preset numbers, preset names, area names, and camera operation status are displayed on the monitor, allowing set up of various camera functions through the OSD menu screen.

Auto-focus 20X, 30X Optical Zoom

The built-in 20X, 30X optical zoom lens with auto-focus is combined with a 32X digital zoom, providing a maximum of 640X, 960X zoom.

Wide Range Auto functions

Preset : Up to 255 programmable presets.

Tour : Up to 8 programmable Tours consisting of presets with individual dwell time.

Scan : Repeatedly pan & tilt operating between two positions. (Max.8)

Pattern : Up to 4 programmable Patterns memorizing the PTZ movement.

Area : Up to 16 programmable Area display sets.

Alarm : Move the camera to programmed Preset position with Alarm trigger. (Max.1)

Privacy: Up to 8 programmable Privacy masking.

Home Position : Home Position specify the main image display area.

WDR (Wide dynamic range)

The Camera delivers clear, high quality pictures even in backlight, by increasing exposure in dark areas while decreasing it in bright areas a corrected image with clear details results.

Variable speed Pan/Tilt control

In manual mode, sophisticated operating is possible at zoom in state by speed correcting function.

Eco-friendly Green Energy product

Minimize power consumption and save the earth by utilizing the WTK Series all-in-one camera system.

4. SETTING & INSTALLATION

4.1 Unpacking

Guiding sticker for installation

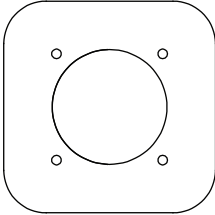

Manual

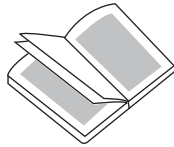

Detaching Hook

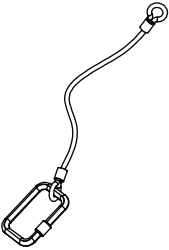

4PIN Communication Terminal

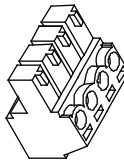

Accessories

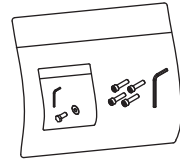

L-WRENCH(2.5mm/6mm),
M8 HEX SCREW, M8 WASHER,
M8 WRENCH SCREW

Switched-Mode Power Supply

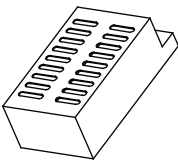

MAIN CABLE

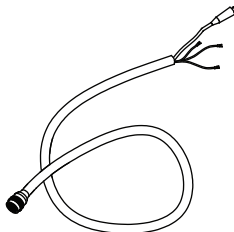

POWER CABLE

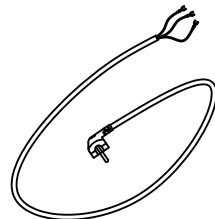

4.2 DIP Switch Setting

Before starting up the camera, set the protocol, camera address and details with dip-switches referring to the following.

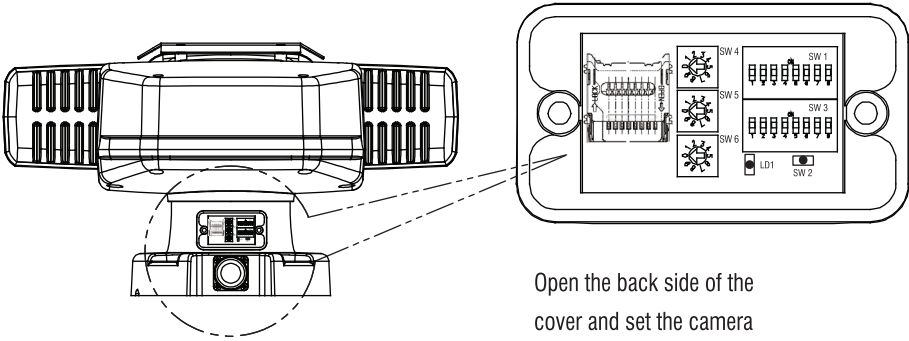

Open the back side of the cover and set the camera

Camera ID (ADDRESS)

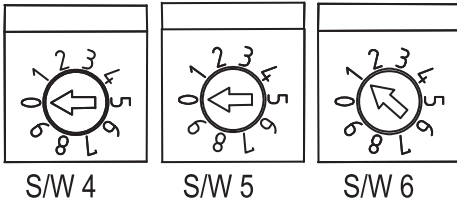

S/W 4 : 100 digit of ID
S/W 5 : 10 digit of ID
S/W 6 : 1 digit of ID

Ex) S/W 4=0, S/W 5=0, S/W 6=1

Address=001

Each camera must have a unique address(ID). Identical ID's on the same line may damage the control circuit caused by an electric short.

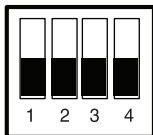
SW 3**PROTOCOL**

1	2	3	4	PROTOCOL
0	0	0	0	EZ
0	0	0	1	PELCO D
0	0	1	0	PELCO P
0	0	1	1	WTX
0	1	0	0	SJ1000
0	1	0	1	NC
0	1	1	0	NC
0	1	1	1	NC
1	0	0	0	NC

SW 3**BAUDRATE**

5	6	7	BAUDRATE
0	0	0	2400
0	0	1	4800
0	1	0	9600
0	1	1	19200
1	0	0	38400
1	0	1	57600
1	1	0	NC
1	1	1	NC

SW 3 NTSC/PAL

8	VIDEO OUT
0	NTSC
1	PAL

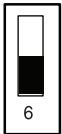
SW 1 IP SELECT

6	IP SELECT
0	IP OFF
1	IP ON

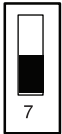
SW 1 RS485 LOOP (TERMINATION)

7	RS LOOP
0	OFF
1	ON

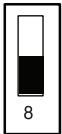
SW 1 RS MODE

8	RS MODE
0	RS-422
1	RS-485

4.3 Cable Connection

4.3.1 Basic Diagram of Cable Connection

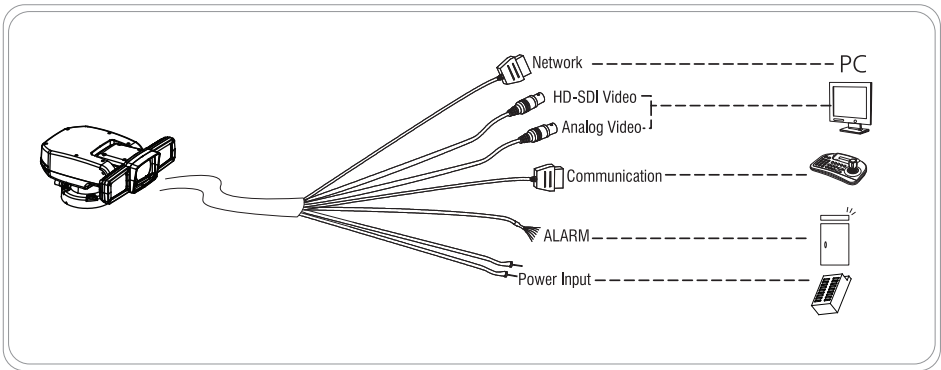

4.3.2 Video Output Connection

Connect the video out (BNC) to the monitor or HD SDI video input of DVR.

4.3.3 RS-485 / RS-422 Communication Connection

It can be remotely controlled by an external device or control system, such as a control keyboard or DVR, using RS-485 half-duplex, RS-422 duplex or simplex serial communication signals.

After inserting 4pin communication terminal of accessory package to green port of main cable, connect marked RX+, RX- to TX+ and TX- of the RS-485 control system. If control system is RS-422, connect TX+,TX- of controller to RX+ and RX- of the camera. And also connect the TX+, TX- of camera to RX+, RX- of the control device respectively. Total length of the cable for communication should not exceed 1.2Km.

4.3.4 Alarm Connection

It can operate specific motion receiving external Alarm Device(Sensor) signal(Max 1 Alarm.)

Connect the alarm cable to external Alarm Device referring to below, directions.

- Black color line : Ground / Red color lines : Alarm 1

4.3.5 Power Connection

- Connect the 2 lines of power cable to the AC terminal of SMPS.

- Connect the main cable to the SMPS terminal.

Main cable	SMPS
Red	+ (Red)
Black	- (Black)

- Connect the power of DC 24V to this camera.

- Use certified Class 2 power supply transformers only.

4.4 Installation

- The following steps of installation and connection work should only be done by qualified service personnel or system installers and should conform to all local codes.
- Be sure to switch the camera off before installation is completed.
- Do not install the camera near the air outlet of an air conditioner.
- Before installation, set camera system with Dip-switches on the 8~9 pages.

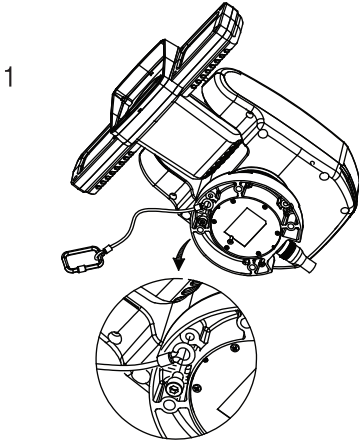

Connect the detaching hook to the camera base and base plate using the enclosed M8 bolt.

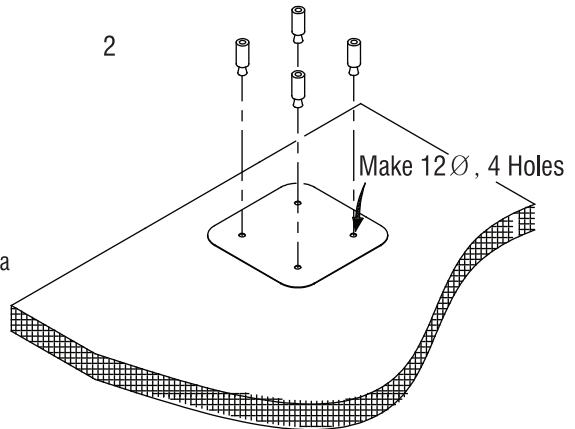

Attach the enclosed guide sticker to the proper position and make 4 holes with 12Ø. And fix the anchor bolts to those holes.

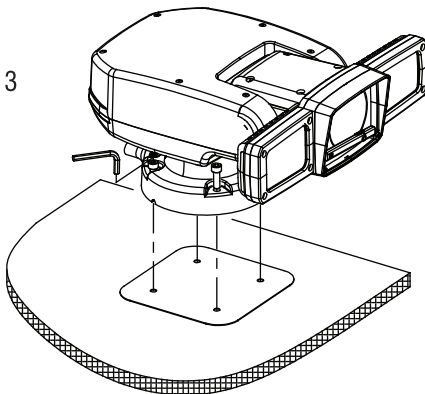

Fix the 4 M8 bolts to 4 anchor bolts using a L-wrench.

4.5 Basic Configuration

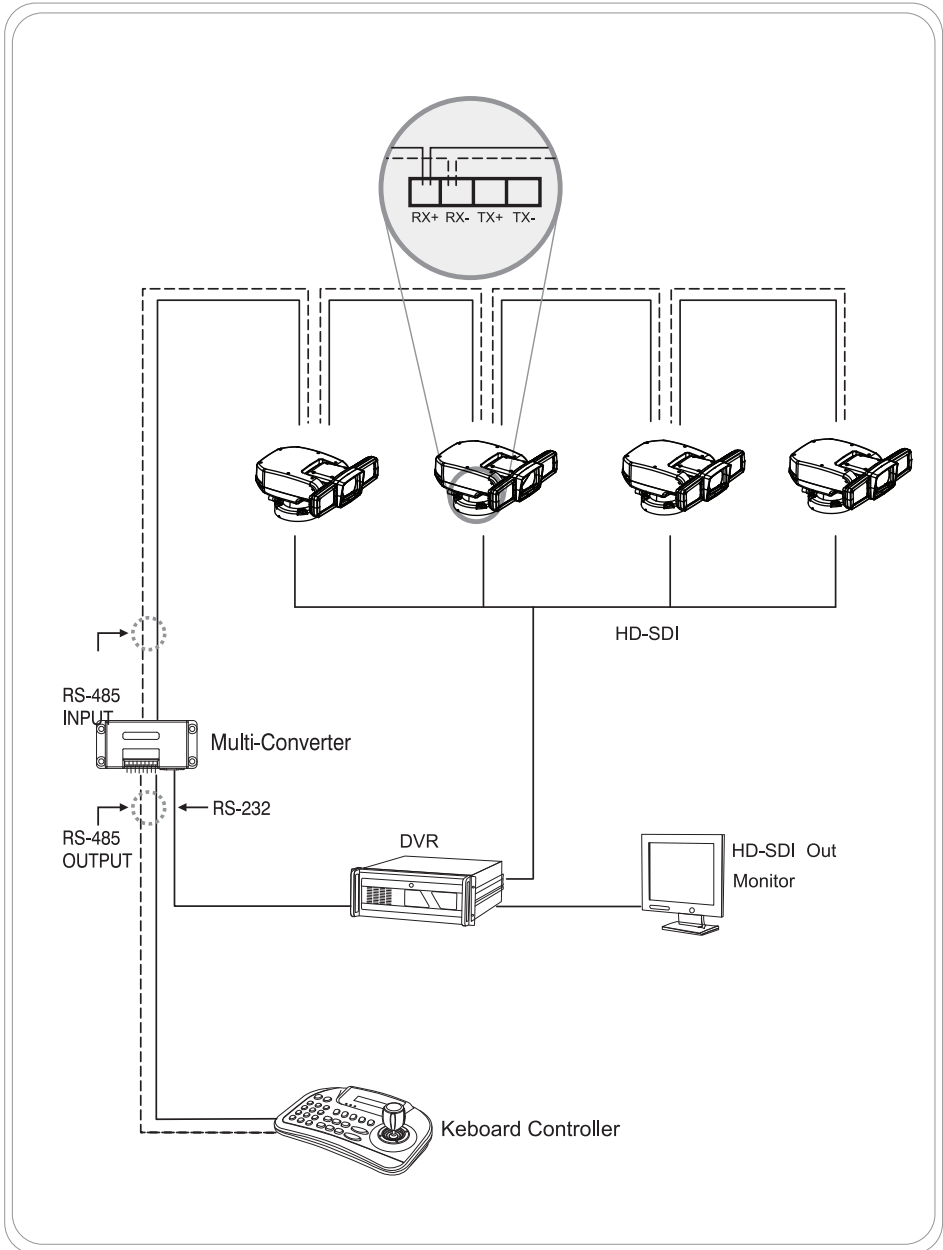

5. MAIN SETUP MENU

5.1 Initialize

When the device is powered on, you can check the address, version, protocol and video setting values.

```

INITIALIZE
PTZ ID      : 001
VERSION    : X. XX
D-OUTPUT   : 1080p30/NTSC

PROTOCOL   : PELCO-D
BAUDRATE   : 2400.N.1
CAMERA     : XX XXX. OK
            VER: XX, XX
▷ PAN INIT  : ..... OK
▷ TILT INIT : ..... OK

▷ NORMAL SETTING WAIT ...
    
```

5.2 Motion Setting

5.2.1 Preset

```

MAIN MENU
-----
MOTION ▶
DOME   ▷
CAMERA ▷
CLEAR  ▷
FACTORY SET
PTZ RESET

EXIT
< NEAR / RIGHT ▷ MOTION >
    
```

```

MOTION MENU
-----
PRESET ▶
TOUR   ▷
SCAN   ▷
PATTERN ▷
AREA   ▷
ALARM  ▷
PRIVACY ▷
HOME POS ▷

BACK   EXIT
< NEAR / RIGHT ▷ PRESET >
    
```

The preset function is that the camera memorizes positions of the pan/tilt and zoom. This function is a representative function of the speed dome which can find memorized preset positions just by selecting the preset No. A Maximum of 255 Preset positions are toured in order.

(1) Select the Preset number

P001 : Defined Preset number / 001 : Undefined Preset number

Move :  JOYSTICK Select :  NEAR

```

PRESET MENU
-----
NUMBER : 001
TITLE  :
FOCUS  : AUTO
POSITION SET ▶
EXIT TIME : OFF
EXTEND SET ▶

SAVE   CLR   BACK   EXIT
< NEAR / RIGHT ▷ PRESETNUM >
    
```

```

PRESET MENU
PRESET SELECT (1)
001 002 003 004 005
006 007 008 009 010
011 012 013 014 015
016 017 018 019 020
021 022 023 024 025
026 027 028 029 030
031 032 033 034 035
036 037 038 039 040
041 042 043 044 045

<SEL ▷NEAR /MOVE & JOYSTICK>
<EXIT ▷FOCUS NEAR>
    
```

(2) Set the Preset TITLE

Move :  Select :  or  Delete :  or 

It's available to set the desired TITLE, displayed on the executing screen of Preset.



After the TITLE is set, push the NEAR button to exit.

(3) Select the focus mode for Preset

① Select the Focus menu

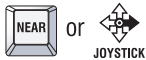

② Move and set the Focus Menu

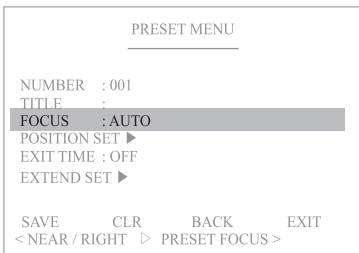

On focus menu, there are 3 modes : AUTO, MANUAL, ONESHT. It allows detailed settings for the preset.

(4) Define the Preset position

① Select the Position menu

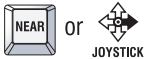

② Move and set the position



③ Set & Back

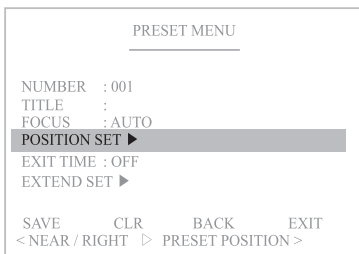

(5) EXIT TIME

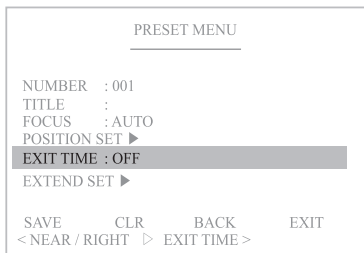

Setting the dwell time to exit Preset mode after completing Preset working.
 (OFF / 5SEC / 10SEC / 20SEC / 30SEC / 1MIN / 5MIN / 10MIN / 30MIN) ※ Default : OFF

Select :  or  Set ON :  Set OFF : 

(6) EXTEND SET

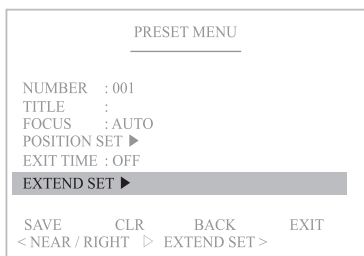

Set the additional preset functions.

AE MODE

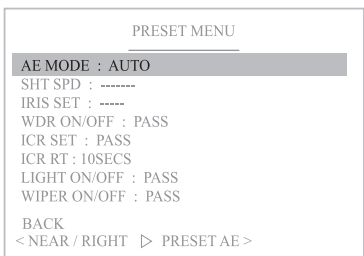

Select AUTO, SHUTTER, IRIS and PASS MODE.

Select :  or  Set ON :  Set OFF : 

SHUTTER SPD

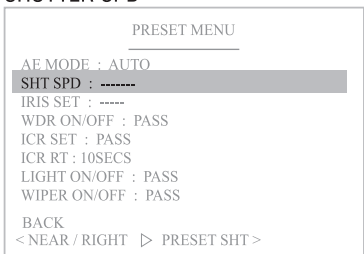

Set shutter speed in the AE MODE.

Select :  or  Set ON :  Set OFF : 

IRIS SETTING

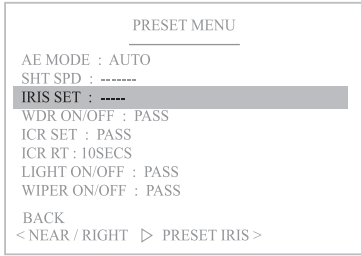

Set IRIS value in the AE MODE. (0~13)

Select :  or  Set ON :  Set OFF : 

WDR ON/OFF

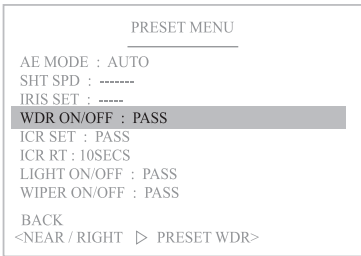

Set WDR funtion.

Select PASS, ON and OFF.

Select :  or  Set ON :  Set OFF : 

ICR SETTING

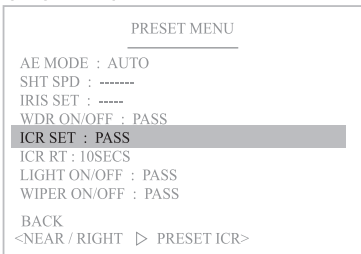

Select PASS, DAY, NIGHT and AUTO in the IR LED.

Select :  or  Set ON :  Set OFF : 

ICR RT SETTING

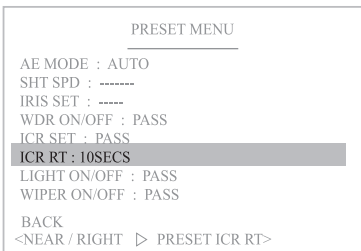

After checking an image, Set IR synchronization time.

(Factory default is 10SEC)

Select :  or  Set ON :  Set OFF : 

LIGHT ON/OFF

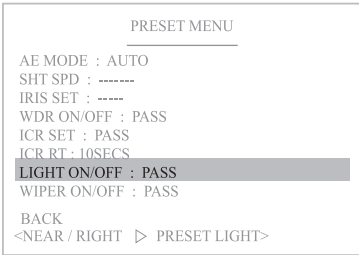

Select PASS, ON and OFF.



WIPER ON/OFF

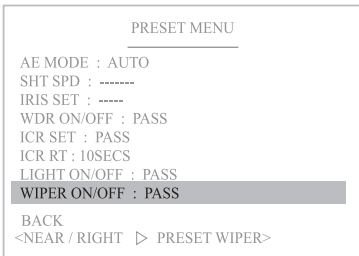

Select PASS, ON and OFF.



(7) "Save" above setting Pattern data to the memory.

(8) "CLR" means above setting Pattern data will not be saved and be cleared.

(9) "BACK" means it goes back to the previous menu :Motion.

(10) "EXIT" means it goes out of MENU.

5.2.2 Tour

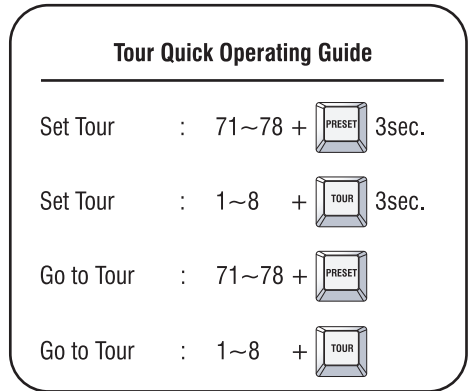
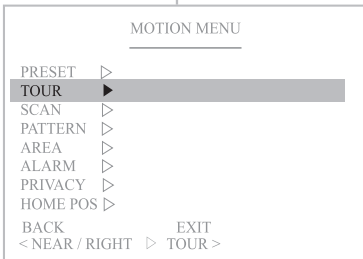
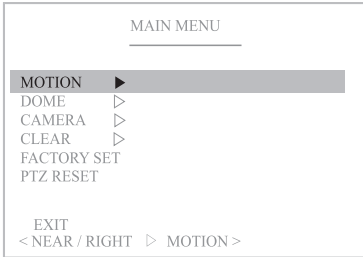

The Tour function consists of several presets run by turn. It is also adjusts the moving speed (1~63 step) and dwell time (1~99secs). Maximum of 8 Tour functions are toured in order. (※ 1 Tour can be set for 16 presets.)

(1) Select the Tour number

T01 : Defined Tour number / 01 : Undefined Tour number

Move : Select :

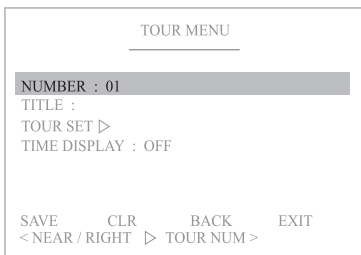

(2) Set the Tour TITLE

Move :  JOYSTICK Select :  or  JOYSTICK Delete :  or  JOYSTICK

It's available to set the desired TITLE, displayed on the executing screen of Tour.

```

      TOUR MENU
      -----
NUMBER : 01
TITLE :
TOUR SET >
TIME DISPLAY : OFF

SAVE   CLR   BACK   EXIT
<NEAR / RIGHT > TOUR TITLE >
    
```

```

      TOUR TITLE EDIT
      -----
TITLE :
      0 1 2 3 4 5 6 7 8 9 (
      ) A B C D E F G H I J K
      L M N O P Q R S T U V W
      X Y Z . / , + - = < > O

<STORE > > TELE   MOVE > > JOYSTICK >
<DELETE > > WIDE  BACK > > NEAR   >
    
```

After the TITLE is set, push the NEAR button to exit.

(3) Define the Preset position

- ① Move to the set-up window ② Move and set the position ③ Set & Back

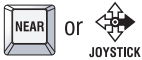

```

      TOUR MENU
      -----
NUMBER : 01
TITLE :
TOUR SET >
TIME DISPLAY : OFF

SAVE   CLR   BACK   EXIT
<NEAR / RIGHT > TOUR SET >
    
```

```

      TOUR EDIT (01)
      -----
NO   PRESET   SPEED   DWELL
01   ◀ 01     63      01
02   ◀ 02     63      01
03   XX      XX      XX
04   XX      XX      XX
05   XX      XX      XX
06   XX      XX      XX
07   XX      XX      XX
08   XX      XX      XX
<SEL & NEAR   PRESET & LEFT >
<SEL & NEAR   DELETE   WIDE >
    
```

```

      TOUR MENU
      PRESET SELECT 1
      -----
0001 002 003 004 005
      006 007 008 009 010
      011 012 013 014 015
      016 017 018 019 020
      021 022 023 024 025
      026 027 028 029 030
      031 032 033 034 035
      036 037 038 039 040
      041 042 043 044 045
      <SEL > > NEAR / MOVE & JOYSTICK >
      <EXIT > FOCUS NEAR
    
```

(4) Time Display

```

      TOUR MENU
      -----
NUMBER : 01
TITLE :
TOUR SET >
TIME DISPLAY : OFF

SAVE   CLR   BACK   EXIT
<NEAR / RIGHT > TIME DISPLAY >
    
```

Display the remain time of each Preset dwell time during Tour operation.(OFF / ON) ※ Default : OFF

Select :  JOYSTICK or  NEAR Set ON :  JOYSTICK

Set OFF : 

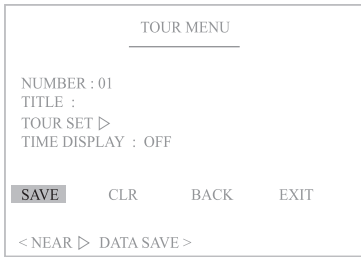

- (4) "Save" above setting Pattern data to the memory.
- (5) "CLR" means above setting Pattern data will not be saved and be cleared.
- (6) "BACK" means it goes back to the previous menu :Motion.
- (7) "EXIT" means it goes out of MENU.

5.2.3 Scan

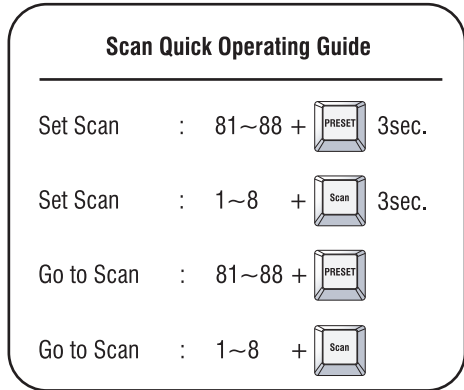
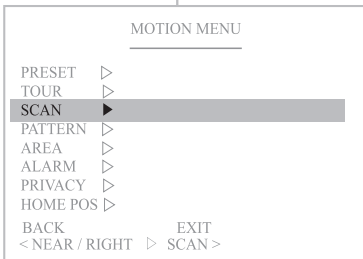
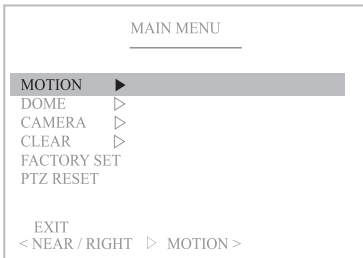

The Scan function means that the camera keeps panning between two programmed pan positions. It is also adjusts the moving speed(1~63 step). Maximum 8 Scan functions are toured in order.

(1) Select the Scan number

S01 : Defined Scan number / 01 : Undefined Scan number

Move :  Select : 

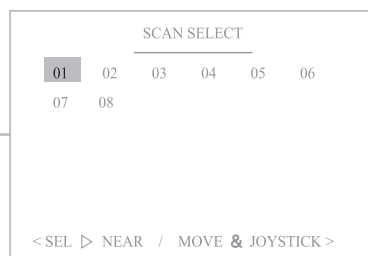
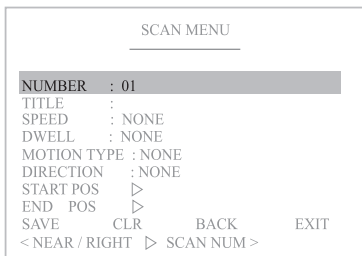

(2) Set the Scan TITLE

Move :  JOYSTICK Select :  or  JOYSTICK Delete :  or  JOYSTICK

It's available to set the desired TITLE, displayed on the executing screen of Scan.

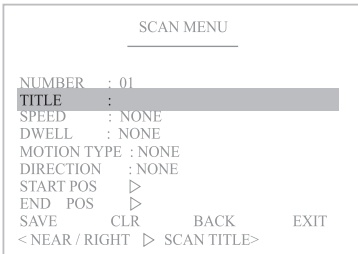

After the TITLE is set, push NEAR button to go out.

(3) Set the Scan speed



Increase :  or  JOYSTICK

Decrease :  or  JOYSTICK

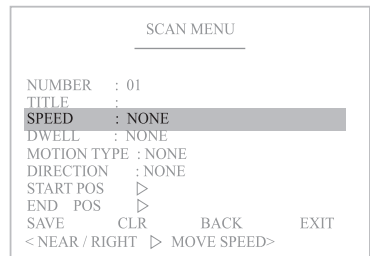
It adjusts the moving speed from 1~63 steps.



(4) Set the Dwell Time

Increase :  or  JOYSTICK

Decrease :  or  JOYSTICK

Dwell time means the time that the camera stay at the start & end pan positions.

It's adjustable from 00~59 seconds.

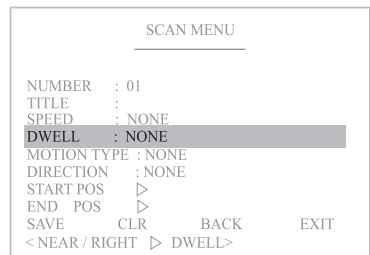

(5) Set the Motion Type

Set PAN/TILT direction

When PAN is set, PAN SCAN is proceeded with the specified coordinate value.

When TILT is set, TILT SCAN is proceeded with the specified coordinate value.

Select :  or  Set ON : 

Set OFF : 

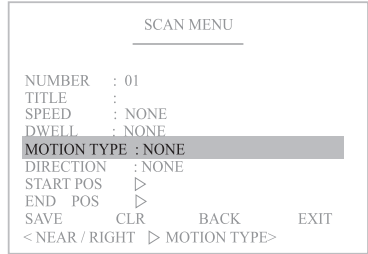

(6) Set the Direction

PAN : Select Clock Wise or C_Clock Wise direction

When select C_Clock WISE, counterclockwise progression

When select Clock WISE, clockwise progression

TILT : Set the UP & DOWN.

Select :  or  Set ON : 

Set OFF : 

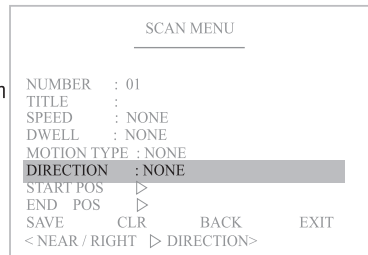

(7) Define the Start position

① Select Start Pos menu

 or 

② Move and set the position



③ Go back



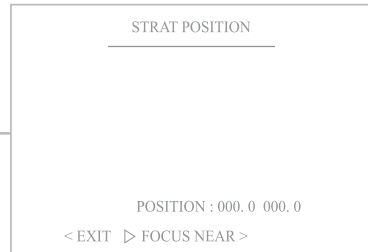
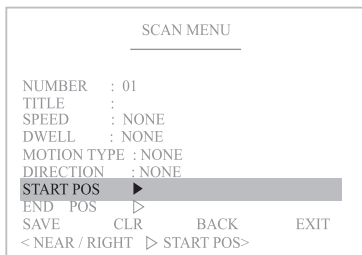

(8) Define the End position

① Select End Pos menu

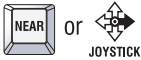

② Move and set the position



③ Go back

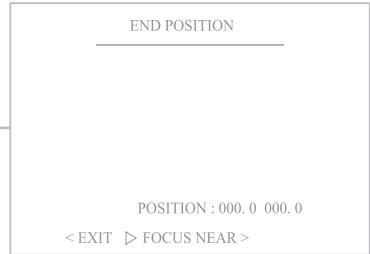
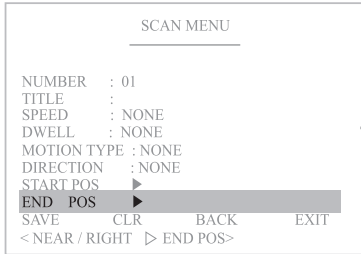

- When Motion type is PAN, Pan is available.
- When Motion type is TILT, TILT is available.

(9) "Save" above setting Pattern data to the memory.

(10) "CLR" means above setting Pattern data will not be saved and be cleared.

(11) "BACK" means it goes back to the previous menu :Motion.

(12) "EXIT" means it goes out of MENU.

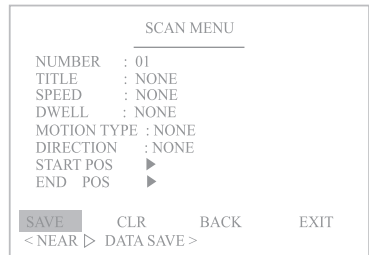

5.2.4 Pattern

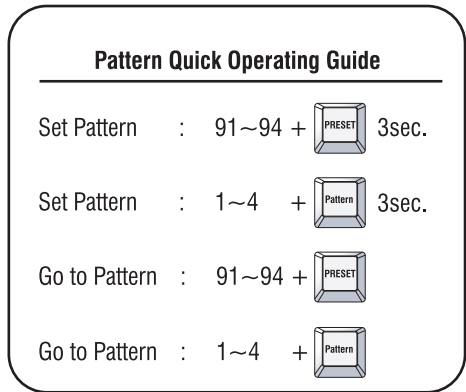
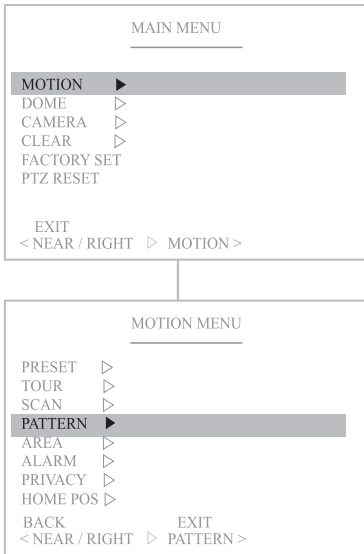

The Pattern function memorizes User's random moving path and zoom ratio. Total recording time limit is 65secs and maximum 4 Pattern functions are toured in order.

(1) Select the Pattern number

PAT01 : Defined Pattern number / 01 : Undefined Pattern number

Move : Select :

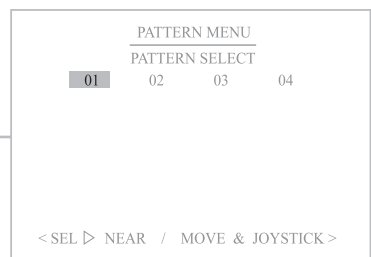
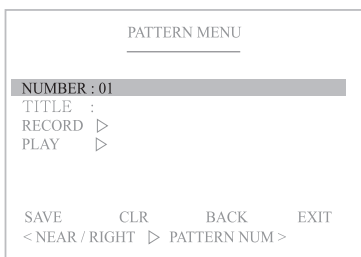

(2) Set the Pattern TITLE

Move :  Select :  or  Delete :  or 

It's available to set the desired TITLE, displayed on the executing screen of Pattern.

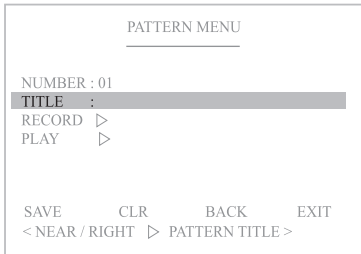

After the TITLE set, push NEAR button to go out.

(3) Record and Save the User's random Pattern data

- ① Select the "Record" Menu ② Move and record the pattern ③ NEAR -> EXIT
 FAR -> RECORD ON

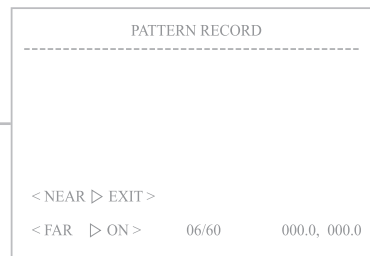
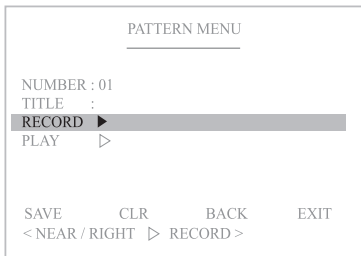
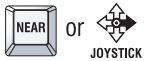

(4) Play back the recorded Pattern data

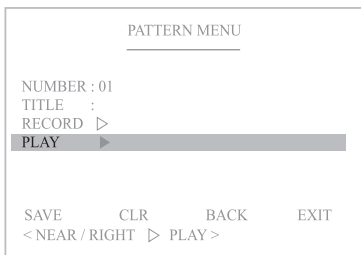

- (5) "Save" above setting Pattern data to the memory.
- (6) "CLR" means above setting Pattern data will not be saved and be cleared.
- (7) "BACK" means it goes back to the previous menu :Motion.
- (8) "EXIT" means it goes out of MENU.

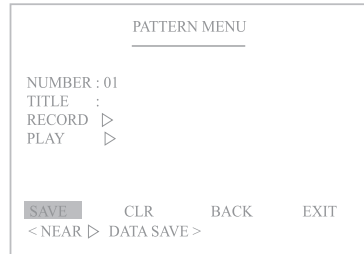

5. 2. 5 Area

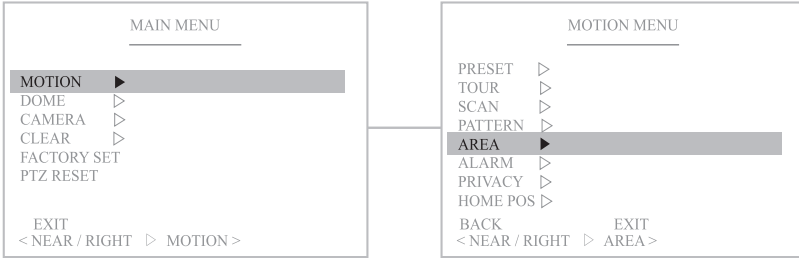

The Area function means that it displays the Area name between two programmed pan positions. Maximun 16 Area functions are toured in order.

(1) Select the Area number

AR 01 : Defined Area number / 01 : Undefined Area number

Move :  Select : 



(2) Set the Area TITLE

Move :  Select :  or  Delete :  or 

It's available to set the desired TITLE, displayed on the executing screen of Area.



After the TITLE set, push NEAR button to go out.

(3) Set the Direction

Select :  or  Set ON :  Set OFF : 

C_Clock WISE is counterclockwise mark, Clock WISE is clockwise mark.

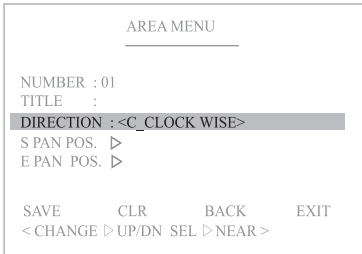

(4) Define the Start pan position

- ① Select the "Start Pan Pos" menu
- ② Move and set the position
- ③ Set & Back

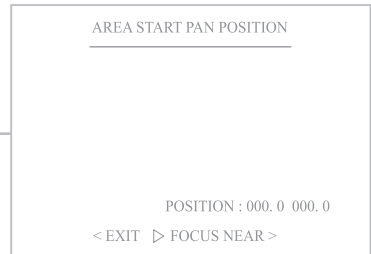
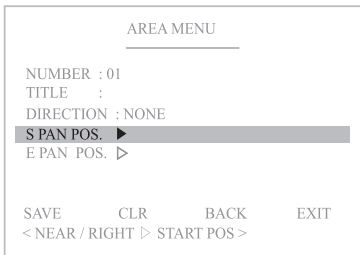
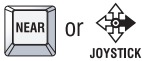

(5) Define the END pan position

- ① Select the "END Pan Pos" Menu
- ② Move and set the position
- ③ Set & Back

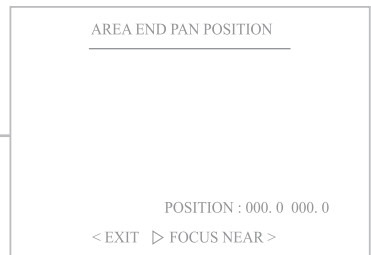
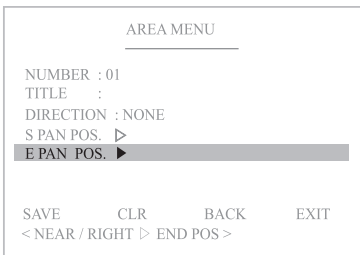
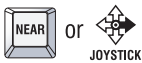

- (6) "Save" above setting Area data to the memory.
- (7) "CLR" means above setting Area data will not be saved and be cleared.
- (8) "BACK" means it goes back to the previous menu :Motion.
- (9) "EXIT" means it goes out of MENU

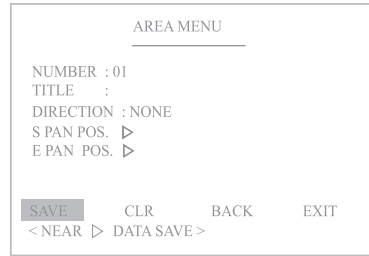

5.2.6 Alarm

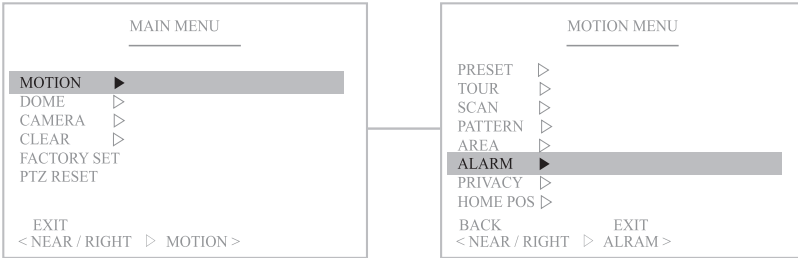

The Alarm function means that the camera moves to the programmed Preset position by the Alarm trigger.
1 Alarm functions are toured in order.

(1) Select the Alarm number

A01 : Defined Alarm number / 01 : Undefined Alarm number

Move :  JOYSTICK Select : 

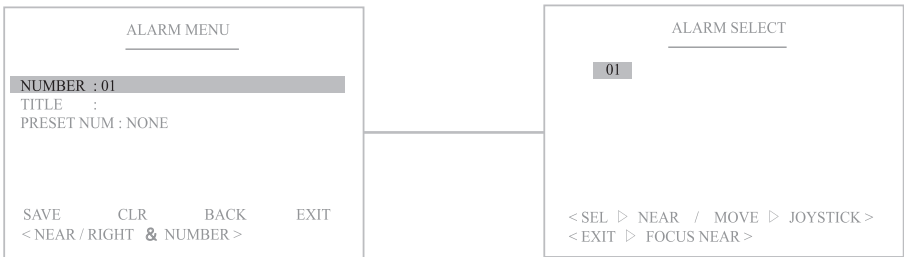

(2) Set the Alarm TITLE

Move :  JOYSTICK Select :  or  JOYSTICK Delete :  or  JOYSTICK

It's available to set the desired TITLE, displayed on the executing screen of Alarm.

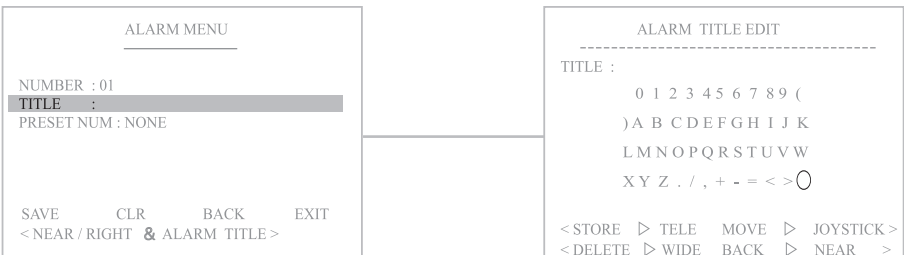

After the TITLE is set, push the NEAR button to exit.

(3) Define the Preset position with Alarm trigger

① Select the "Preset Num"

② Move and set the position

③ Set & Back



OR



JOYSTICK



JOYSTICK

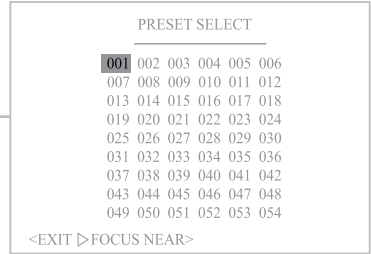
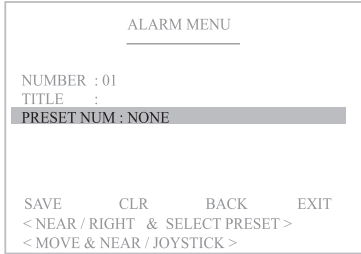

(4) "Save" above setting Alarm data to the memory.

(5) "CLR" means above setting Alarm data will not be saved and be cleared.

(6) "BACK" means it goes back to the previous menu :Motion.

(7) "EXIT" means it goes out of MENU

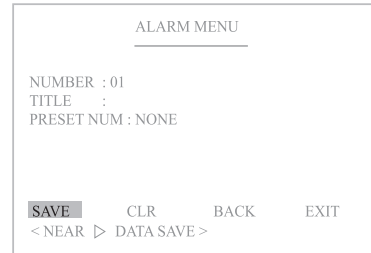

5. 2. 7 Privacy Zone Masking

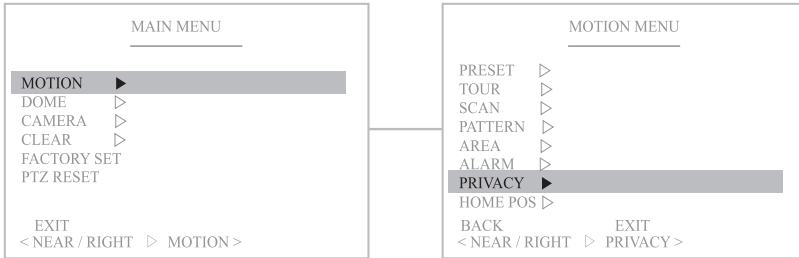

The Privacy Zone Masking function means that it sets the blocking territories to prevent camera functions for the privacy of personal reasons. Maximum of 8 Privacy Zone Masking functions are toured in order.

(1) Select the Privacy Zone number

PR01 : Defined Alarm number / 01 : Undefined Alarm number

Move :  Select : 



(2) Mask set

Move :  Select :  or  Delete :  or 

It's available to set the desired position and size of the blocking territories freely.

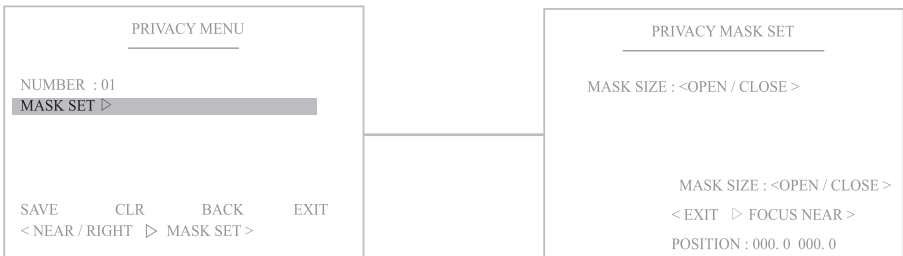

After the Privacy Zone is set, push the NEAR button to go out.

(3) "Save" above settings of Privacy Zone data to the memory.

(4) "CLR" means above setting of Privacy Zone data will not be saved and be cleared.

(5) "BACK" means it goes back to the previous menu :Motion.

(6) "EXIT" means it goes out of MENU.

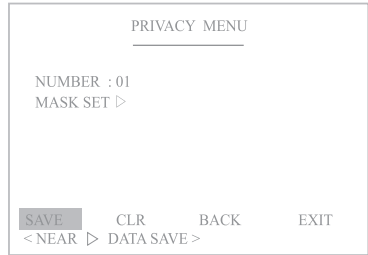

5.2.8 Home Position

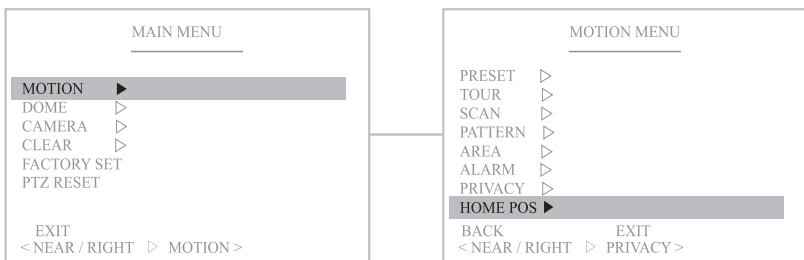

Home Position specify the main image display area.

(1) Home Position ON/OFF setting

Move :  Select : 

JOYSTICK NEAR

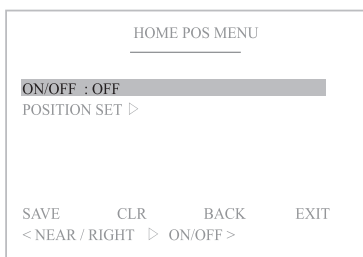

(2) Home Position SET

Move :  Select : 

JOYSTICK NEAR

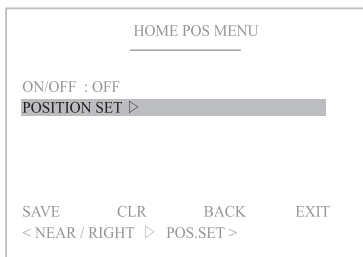

Quick Operating Guide
Go to Home Position : 255+SET



5.3 Dome Setting



Pan, Tilt, Zoom motion is adjustable in the “Dome Setting” Menu.

5.3.1 Set the Dome camera title

Move :  JOYSTICK Select :  or  JOYSTICK Delete :  or  JOYSTICK

It's available to set the desired camera title.

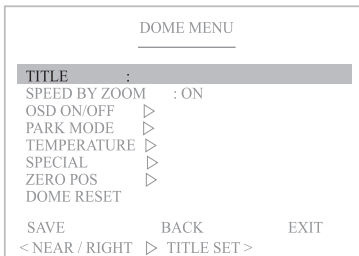

After the TITLE is set, push NEAR button to exit.

5.3.2 Speed by Zoom ON/OFF Set

When this function is ON, the pan/tilt speed is inversely adjusted to the zoom ratio.

(Available to check with max zoom rate.)

Select :  JOYSTICK or  Set ON :  JOYSTICK

Set OFF : 

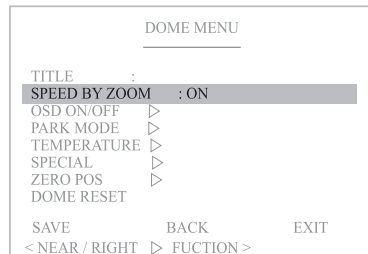

5. 3. 3 OSD ON/OFF Set

You can select the OSD ON to shown on the screen or clear by selecting OFF in this function.

Select :  or  Set ON :  Set OFF : 

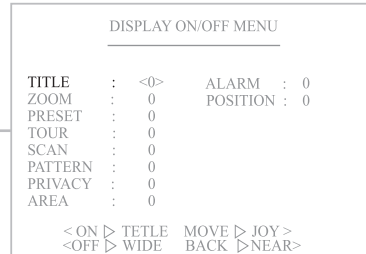
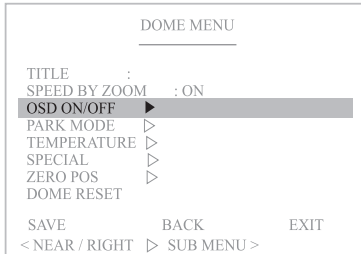

5. 3. 4 PARK MODE

This function enables to locate the camera to specific position automatically if operator doesn't operate the controller for a while.

 or  JOYSTICK

- ON/OFF : Select ON/OFF
- TIME : Select 10 sec~1 HOUR
- MOTION : Set PRESET / TOUR / SCAN / PATTERN
- NUMBER
- PRESET : 1~255
- TOUR : 1~8
- SCAN : 1~8
- PATTERN : 1~4

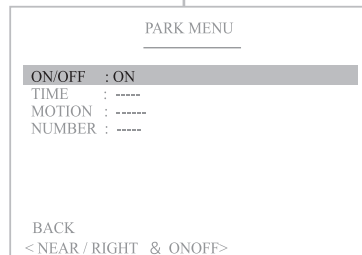
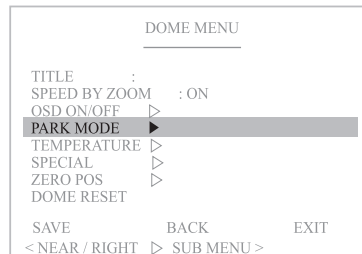

5.3.5 TEMP MODE

It shows you the current temperature and you can also set the value manually. The compulsory Fan & Heater operation is a useful function to remove humidity.

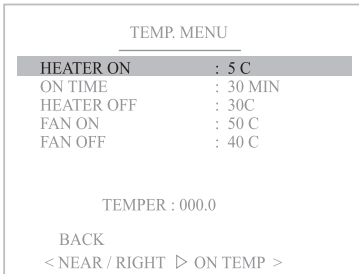
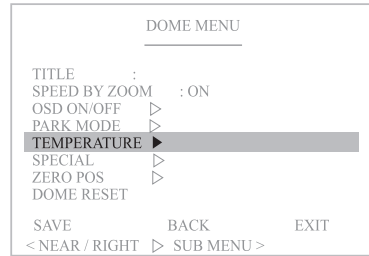

(1) HEATER ON

Set the operating temperature of the heater. (0~70°C)

Select :  or  Set ON : 

Set OFF : 

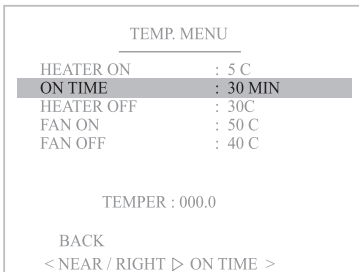

(2) ON TIME

Set the operating time of the heater.
 - By 10min. (10~60 min.)

Select :  or  Set ON : 

Set OFF : 

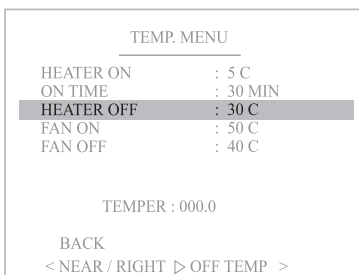

(3) HEATER OFF

Set the temperature of heater OFF. (0~70°C)

Select :  or  Set ON : 

Set OFF : 

TEMP. MENU	
HEATER ON	: 5 C
ON TIME	: 30 MIN
HEATER OFF	: 30 C
FAN ON	: 50 C
FAN OFF	: 40 C
TEMPER : 000.0	
BACK	
< NEAR / RIGHT ▷ FAN ON >	

(4) FAN ON

Set the operating temperature of the Fan. (0~70°C)

Select :  or  Set ON : 

Set OFF : 

TEMP. MENU	
HEATER ON	: 5 C
ON TIME	: 30 MIN
HEATER OFF	: 30 C
FAN ON	: 50 C
FAN OFF	: 40 C
TEMPER : 000.0	
BACK	
< NEAR / RIGHT ▷ FAN OFF >	

(5) FAN OFF

Set the temperature of Fan OFF. (0~70°C)

Select :  or  Set ON : 

Set OFF : 

5.3.6 Special

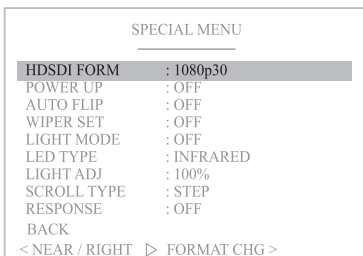
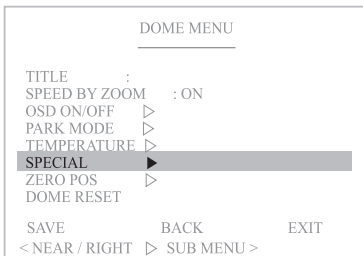

(1) HD SDI FORMAT

PAL : 1080p25 / 720P50 / 1080i50 / 1080i59
 NTSC : 1080p30 / 720P60 / 1080i60 / 1080i59

※ HD SDI FORMAT can be variable according to product specification

Select :  or  Set ON :  JOYSTICK

Set OFF : 

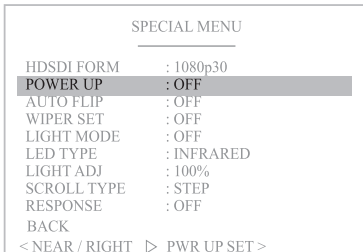

(2) POWER UP

When this function is ON, the camera memorizes the latest action and restores, it from sudden power failure.

※ Factory default is OFF.

Select :  or  Set ON :  JOYSTICK

Set OFF : 

(3) AUTO FLIP

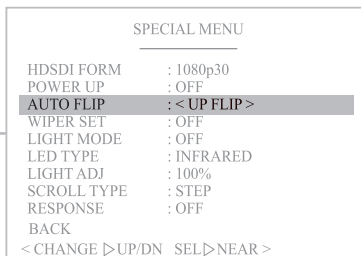
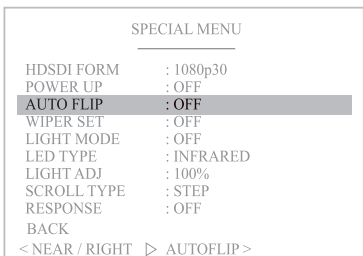

OFF : AUTO FLIP OFF

※ Factory default is OFF.

UP FLIP

* TILT UP FLIP.

SPECIAL MENU	
HSDSI FORM	: 1080p30
POWER UP	: OFF
AUTO FLIP	: < DN FLIP >
WIPER SET	: OFF
LIGHT MODE	: OFF
LED TYPE	: INFRARED
LIGHT ADJ	: 100%
SCROLL TYPE	: STEP
RESPONSE	: OFF
BACK	
< CHANGE ▷ UP/DN_SEL ▷ NEAR >	

DN FLIP
* **TILT DOWN FLIP**





SPECIAL MENU	
HSDSI FORM	: 1080p30
POWER UP	: OFF
AUTO FLIP	: < U&D FLIP >
WIPER SET	: OFF
LIGHT MODE	: OFF
LED TYPE	: INFRARED
LIGHT ADJ	: 100%
SCROLL TYPE	: STEP
RESPONSE	: OFF
BACK	
< CHANGE ▷ UP/DN_SEL ▷ NEAR >	

UP_DN FLIP
* **TILT UP and DOWN FLIP**

SPECIAL MENU	
HSDSI FORM	: 1080p30
POWER UP	: OFF
AUTO FLIP	: OFF
WIPER SET	: OFF
LIGHT MODE	: OFF
LED TYPE	: INFRARED
LIGHT ADJ	: 100%
SCROLL TYPE	: STEP
RESPONSE	: OFF
BACK	
< NEAR / RIGHT ▷ ONOFF >	

(4) WIPER SET





Select ON/OFF to use the wiper function.
※ factory default is OFF.

Select :  or  Set ON : 
Set OFF : 

SPECIAL MENU	
HSDSI FORM	: 1080p30
POWER UP	: OFF
AUTO FLIP	: OFF
WIPER SET	: OFF
LIGHT MODE	: OFF
LED TYPE	: INFRARED
LIGHT ADJ	: 100%
SCROLL TYPE	: STEP
RESPONSE	: OFF
BACK	
< NEAR / RIGHT ▷ TYPE >	

(5) LIGHT MODE





Manually select IR ON/OFF IR operation.

Select :  or  Set ON : 
Set OFF : 

SPECIAL MENU	
HSDSI FORM	: 1080p30
POWER UP	: OFF
AUTO FLIP	: OFF
WIPER SET	: OFF
LIGHT MODE	: OFF
LED TYPE	: INFRARED
LIGHT ADJ	: 100%
SCROLL TYPE	: STEP
RESPONSE	: OFF
BACK	
< NEAR / RIGHT ▷ ONOFF >	

(6) LED TYPE

Set the LED.

Select :  or  Set ON : 
Set OFF : 

SPECIAL MENU	
HSDSI FORM	: 1080p30
POWER UP	: OFF
AUTO FLIP	: OFF
WIPER SET	: OFF
LIGHT MODE	: OFF
LED TYPE	: INFRARED
LIGHT ADJ	: 100%
SCROLL TYPE	: STEP
RESPONSE	: OFF
BACK	
< NEAR / RIGHT ▷ ADJUST >	

(7) LIGHT ADJ

Set the IR brightness.

Select :  or  Set ON : 

Set OFF : 



SPECIAL MENU	
HSDSI FORM	: 1080p30
POWER UP	: OFF
AUTO FLIP	: OFF
WIPER SET	: OFF
LIGHT MODE	: OFF
LED TYPE	: INFRARED
LIGHT ADJ	: 100%
SCROLL TYPE	: STEP
RESPONSE	: OFF
BACK	
< NEAR / RIGHT ▷ TYPE >	

(8) SCROLL TYPE

Set the cursor progress

STEP : by 1 STEP

AUTO : Continuous scroll

Select :  or  Set ON : 

Set OFF : 

SPECIAL MENU	
HSDSI FORM	: 1080p30
POWER UP	: OFF
AUTO FLIP	: OFF
WIPER SET	: OFF
LIGHT MODE	: OFF
LED TYPE	: INFRARED
LIGHT ADJ	: 100%
SCROLL TYPE	: STEP
RESPONSE	: OFF
BACK	
< NEAR / RIGHT ▷ ON/OFF >	

(9) RESPONSE TXD

Tx communication line to transfer the unique value of protocol response.

(Use this function when the protocol is pelco-D 5.0 EZ.)

※ Factory default is OFF.

Select :  or  Set ON : 

Set OFF : 

5.3.7 ZERO POS

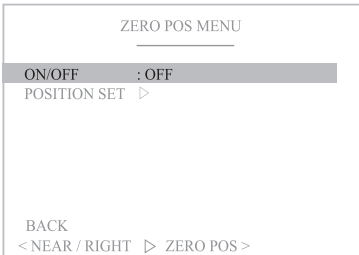
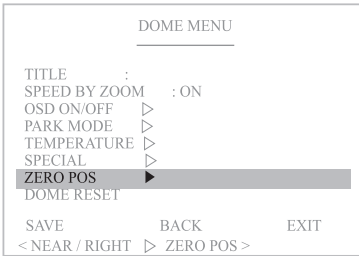

When select ON, the zero position is changeable.
 POSITION change 000.0 / 000.0 value.

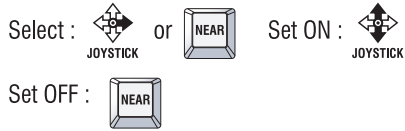

5.3.8 DOME RESET

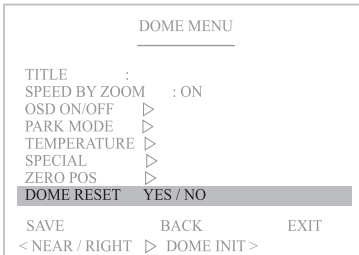

DOME MENU initialization function.

5.4 Clear Setting

Clears the PTZ position and function value.

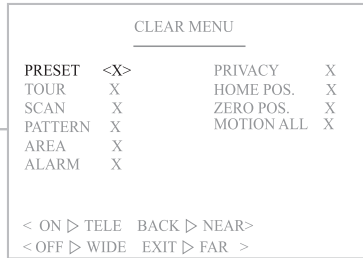
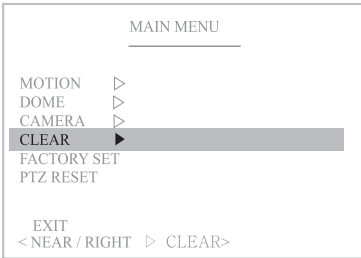

select :  or  Set ON : 

Set OFF : 

5.5 Factory set

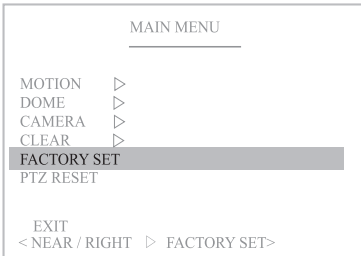

Clear the DOME, CAMERA and MOTION setting value.

 Restore setting values to the factory default.
All existing setting value will be erased.

5.6 PTZ Reset

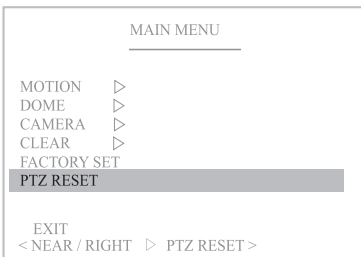

It is a reset function.

5.7 Other Quick Operating Guide

Auto = 240 + set preset

Day = 241 + set preset

Night = 242 + set preset

Wiper On / Off Toggle = 244 + set preset

Heater On / Off Toggle = 245 + set preset

Auto Scan = 99 + set preset

PTZ Menu Open = 95 + set preset(go preset)

Fan On / Off Toggle = 250 + set preset

Camera Factory Set = 253 + set preset

Camera Rens Init = 254 + set preset

PTZ Information = 255 + set preset

6. SPECIFICATIONS

6.1 Mechanical Specifications

6.1.1 MECHANICAL

Pan	: 360° Continuous Pan, 0.1° to 90°/sec.
Pan Preset Speed	: Max.150°/sec, ± 0.1° Accuracy
Tilt	: 90° to 270° tilt angle
Tilt Preset Speed	: Max.150°/sec, ± 0.1° Accuracy
Weight	: Approx. 12 Kg/ Packing 15 Kg

6.1.2 ENVIRONMENTAL

Construction	: Die-casing Aluminum & “O” Ring sealed
	: All internal parts are corrosion protected epoxy powder coating
Ingress Protection	: IP66 Outdoor Application
Color	: Black
Operating Temp	: -20°C to 50°C (In continuous operation with Fan & Heater)
Storage Temp	: -30°C to 60°C
Humidity	: 0% to 90%

6.1.3 FUNCTIONS

Preset	: 255 points, less than 0.1° accuracy
Tour	: 8 programmable
Scan	: 8 scans
Pattern	: 4 patterns
Area	: 16 area
Alarm	: 1 alarm
Privacy	: 8 privacy
Flip	: UP / DOWN / UP&DOWN Flip
Address	: Up to 255 selectable ID (setting with Dip-switches)
Data Communication Control	: RS-485/ RS-422
Protocol	: Multiple Protocol
Baud rate	: 2400, 4800, 9600, 19200, 38400, 57600 bps selectable

6.1.4 ELECTRICAL

Power	: DC24V ~ DC32V
	Power adaptor included
Consumption	: Operating(3A), Max(4.0A, IR light on, Heater on)
Fan & Heater	: 10W / 3.4W

* Design and specifications are subject to change without notice.

6. 2 LED Specification

	Infra Red LED	White LED
Light Distance	200 m(Manual focusing)	
LED	Super IR LED 30 EA (OSRAM 870n) with Lens 12°	Super White LED 30EA (OSRAM 870n) with Lens 12°

7. DIMENSIONS(mm)

